



1. Unpack the luminaire.



2a. Prepare the luminaire for the installation.
With a connector gesis.



2a. Prepare the luminaire for the installation.
With a cable.



3. Connect the 3 core cable to the power supply (Class I.).

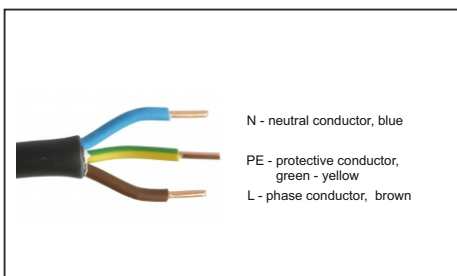

4. Connect the 2 core cable to the power supply (Class II.).

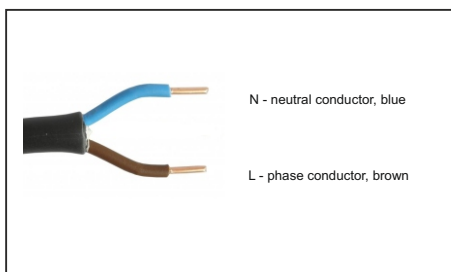

5. Connect the 3 pin connector Gesis to the power supply (Class I.).

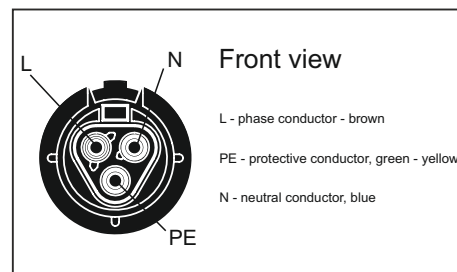

6. Connect the 2 pin connector Gesis to the power supply (Class II.).

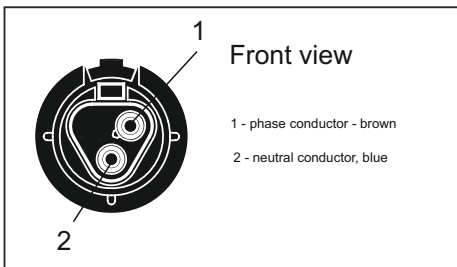

7. Fix the luminaire on the post.
Tighten allen screws with tightening torque of 8 Nm.



8. If installing on 70mm diameter post, loose allen screws.



9. Take out an inner adapter from the bottom part of the luminaire.
Fix the luminaire on the post.
Tighten allen screws with tightening torque of 8 Nm.



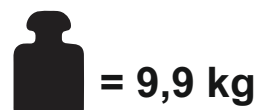
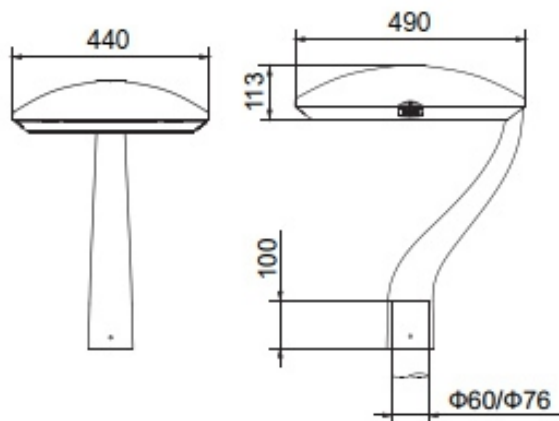

- Recommended installation height up to 6 meters.
- If the external flexible cable or cord of this luminaire is damaged, it shall be exclusively replaced by the manufacturer or his service agent or a similar qualified person in order to avoid a hazard.
- The light sources in this luminaire is only replaceable by the manufacturer or their technicians or a qualified person.

- Caution, risk of electric shock 

- Do not look directly or with optical aids into the light source RG1 d > 0,5 m
- This luminaire operates at mains voltage 220-240V, 50-60 Hz.



- Any modification to this luminaire is forbidden.

- Replace any cracked protective shield.

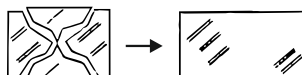

Cleaning:

clean the luminaire with the standard detergents. DO NOT use any abrasive detergents or solvents.

Installation and maintenance:

can provide only a person with an electrical qualification.

ELEKTRO-LUMEN, s. r. o.
 Hranická 505
 753 61 Hranice IV - Drahotuše
 Česká republika

Telefon: +420 581 699 411
Fax: +420 581 699 419
E-mail: el-lumen@el-lumen.cz
Web: www.el-lumen.cz



The company reserves the right to change technical data and printing errors.
 Copyright © ELEKTRO-LUMEN, s. r. o.